

This manual is for reference and historical purposes, all rights reserved.

This page is copyright© by M. Butkus, NJ.

This page may not be sold or distributed without the expressed permission of the producer

I have no connection with any camera company

On-line camera manual library

This is the full text and images from the manual. This may take 3 full minutes for the PDF file to download.

If you find this manual useful, how about a donation of \$3 to: M. Butkus, 29 Lake Ave., High Bridge, NJ 08829-1701 and send your e-mail address so I can thank you. Most other places would charge you \$7.50 for a electronic copy or \$18.00 for a hard to read Xerox copy.

This will allow me to continue to buy new manuals and pay their shipping costs.

It'll make you feel better, won't it?

**If you use Pay Pal or wish to use your credit card,
click on the secure site on my main page.**



**MACROPHOTOGRAPHY AND
PHOTOMICROGRAPHY**

with

EXAKTA

VX IIa



EXAKTA

VX IIa

EXAKTA with a set of bayonet adapter rings and tubes, autocouple extension release, and lens magnifier with top lens (see page 11)

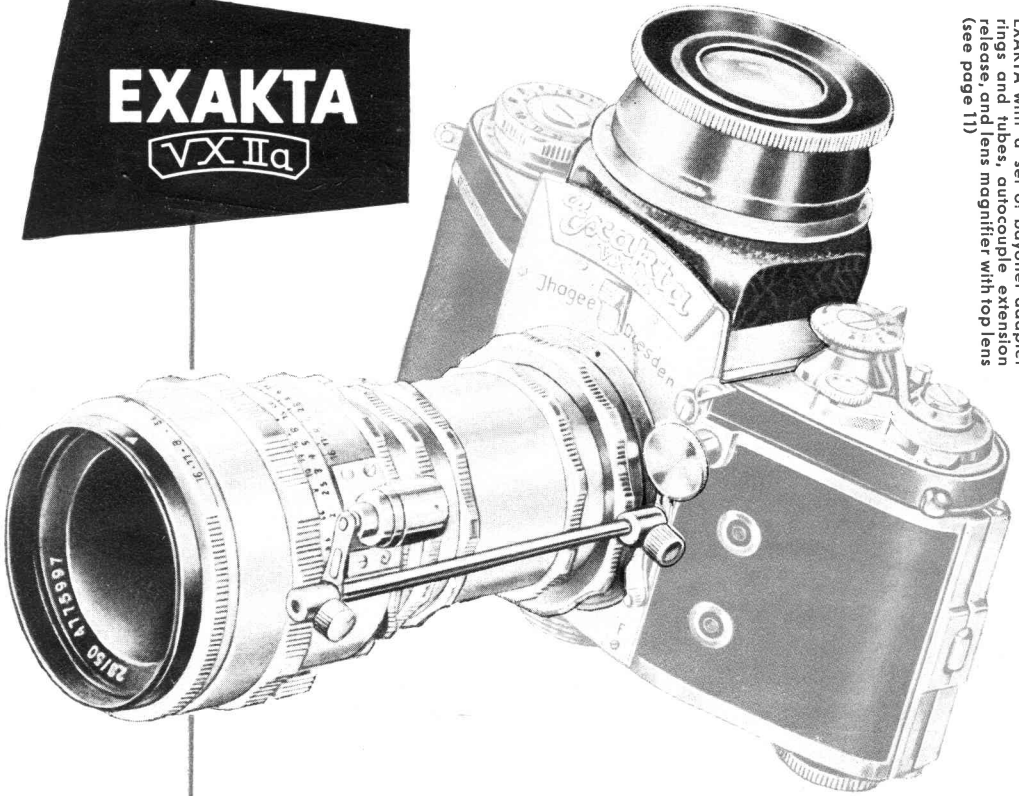

High magnification of small objects

is for many scientists a necessity in their professional work; for the amateur and hobbyist it is a fascinating and useful avocation. With the aid of the EXAKTA the taking of highly magnified pictures of small objects is easy; it is done without any technical difficulties, and the cost is unusually low. Parallax, the horror of close-up photographers, is eliminated when using the EXAKTA because its ground glass focusing screen reflects the identical image that will appear on the film. The smaller the object to be photographed, the shorter the focusing distance from the camera; to do this, however, requires a set of extension tubes (or bellows) to be installed between the camera and lens. The variations of extension are accomplished quite mechanically, but at all times the exact picture area of the film is under control (and is seen on the focusing glass). Depth of field, colour composition, distribution of light and shadow, and the arrangement of the subject can be examined right up to the instant of exposure. This is possible only because viewing and critical focusing is done with the actual picture-taking lens. As a result, the picture you get on film is identical with the image seen on the focusing glass. Furthermore, when you use the EXAKTA, you eliminate all auxiliary and cumbersome optical focusing equipment for close-ups and photomicrography. This simplifies the work and makes it more economical.

The simplest extension increase is sufficient,

to enable one to focus beyond the normal range incorporated on the helical focusing lens mount and to obtain any scale of reproduction required (see table page 4). Bayonet adapter rings or any number of additional extension tubes may be inserted between the interchangeable lens of the EXAKTA and the camera body. The extension may therefore always be changed at a moment's notice to the required focusing distance. At all times the helical focusing mount of the lens allows final critical focusing.

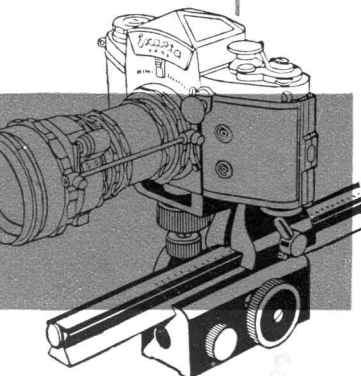

EXAKTA with bayonet adapter rings and tubes, autocouple extension release, and swing angle attachment

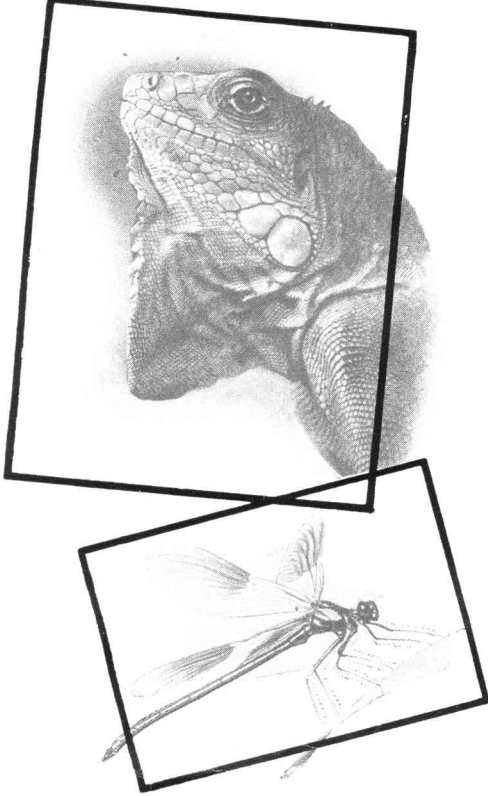

The following accessories are available:

Two-in-one ring No. 187. This permits the use of the shortest possible extension increase of 5 mm. The ring is inserted into the camera bayonet, the front face accepts the lens.

The two Bayonet adapter rings Nos. 181/183. Extension increase of 10 mm. The back ring is inserted into the camera, while the front ring accepts the lens. Screwed together, the two rings can be used as one. Separated they accept the tubes. The back bayonet ring has a clamping ring, that enables the lens with the front bayonet ring and the tubes always to be turned into the normal upright position and locked there.

Three extension tubes. They are available in three sizes: No. 184 = 5 mm, No. 185 = 15 mm, and No. 186 = 30 mm. They can be used in any combination but, possessing screw threads, they must be employed with the bayonet rings Nos. 181/183. The bayonet rings and the three tubes, therefore, are supplied only as a complete set No. 180.

The autocouple extension release No. 149. In order to be able, when using bayonet adapter rings and tubes, to bring into action the automatic diaphragm mechanism of the more recent EXAKTA lenses, the autocouple extension release makes the connection between the lens and the shutter release button of the camera.

The swing angle attachment No. 155.08 may be screwed on a tripod, and by means of the focusing slide, enables critical close-up work. The camera can be swung from the horizontal to the upright position in one simple operation.

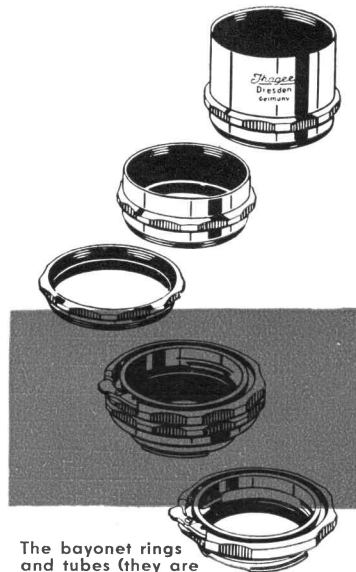

The bayonet rings and tubes (they are suitable for all models of the EXAKTA 24 x 36 mm and for the EXA)

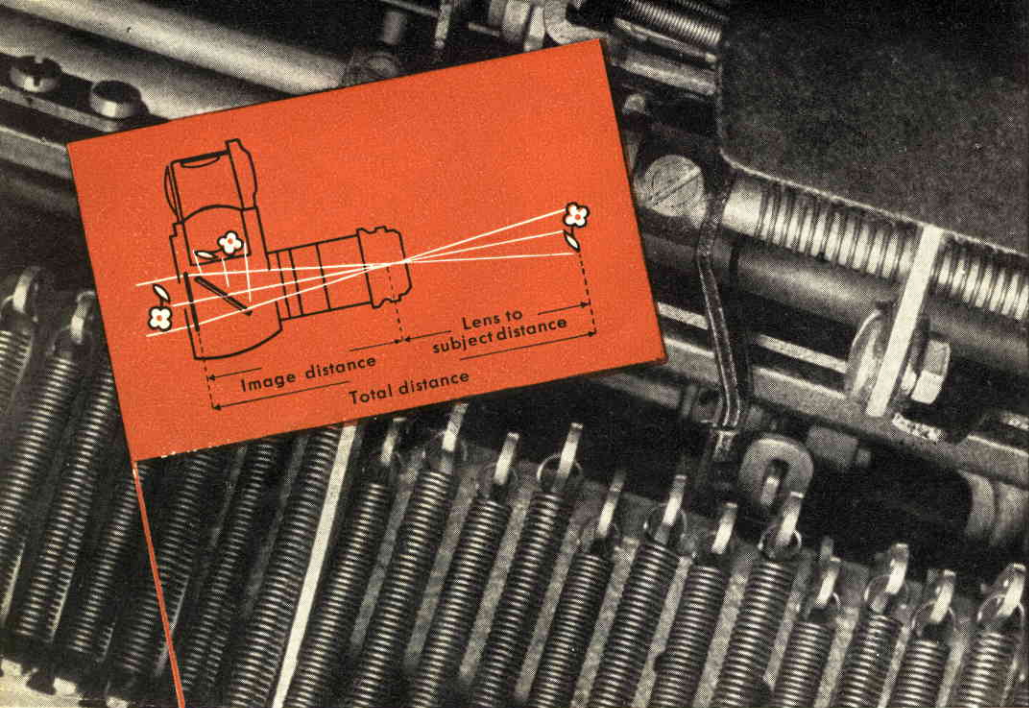

Extension increases

The table shows the distances and scales of reproduction that can be obtained with a two-in-one ring No. 187, and a set of bayonet adapter rings with tubes No. 180. By using additional tubes the working distance can be still further reduced so that at triple extension (image distance of 150 mm or 174 mm) a twofold magnification will be obtained on the negative, at fourfold extension triple magnification etc. The table figures are based on lens focused at infinity. Intermediate values can be obtained by using the lens helical focusing mount. The long helical mounts of the modern lenses allow greater overall distances to be covered. Increase in image distance requires increase in exposure time, and it is for that reason the exposure factors are included in the table. Scale of reproduction 0.8 = image size is 0.8 of subject size.

Extension Tubes needed Calculated for (description of Nos. see page 3)	extension dist. mm	for 50 mm lenses					for 58 mm lenses				
		total dist. mm	image dist. mm	lens-to- subject dist. mm	expo- sure factor	scale of repro- duction	total dist. mm	image dist. mm	lens-to- subject dist. mm	expo- sure factor	scale of repro- duction
No. 187	5	605	55	550	1,2	0,1	794	63	731	1,2	0,09
Nos. 181/183	10	360	60	300	1,5	0,2	462	68	394	1,4	0,17
Nos. 181/183+184	15	282	65	217	1,7	0,3	355	73	282	1,6	0,26
Nos. 181/183+184+187	20	245	70	175	2,0	0,4	304	78	226	1,8	0,35
Nos. 181/183+185	25	225	75	150	2,3	0,5	275	83	192	2,1	0,43
Nos. 181/183+184+185	30	213	80	133	2,6	0,6	258	88	170	2,3	0,52
Nos. 181/183+184+185+187	35	206	85	121	2,9	0,7	247	93	154	2,6	0,60
Nos. 181/183+186	40	203	90	113	3,3	0,8	240	98	142	2,9	0,69
Nos. 181/183+184+186+187	50	200	100	100	4,0	1,0	233	108	125	3,5	0,86
Nos. 181/183+184+185+186	60	202	110	92	4,9	1,2	232	118	114	4,2	1,03

EXAKTA

VX IIa



Macrophotography

All small objects that normally require close inspection with the naked eye, perhaps even with the aid of a low powered magnifier necessarily have to be photographed within close proximity of the camera lens. This is where EXAKTA is of paramount importance in connection with the whole sphere of scientific technique, and covering all practical work of this nature for the professional photographer, and indeed any of the large number of other tasks of special significance. The EXAKTA accomplishes easily all such work by nature of the basic design and mechanical extension. All forms of copying, whether stamps, documents are in fact included in this category. Things that interest the scientist from the professional point of view attract the amateur photographer, perhaps due to pictorial beauty in pattern or colour, i. e. insects, flowers, plants, stones, coins, etc. Nor should we forget still life of miniature objects. Tiny and insignificant objects assume a new and striking appearance when photographed at close range and greatly enlarged. Colour macrophotographs may be undertaken with 35mm EXAKTA without effort, the finder image showing the subject in natural colour. Needless to say, any special lenses employed with or without extension tubes may also be used. Wide angle lenses permit closer working distances, long focus lenses at greater distances, assuming the scale of reproduction remains unchanged. Either method may prove of great value. As usual the image can be controlled according to choice by the varying focusing systems of the EXAKTA. Normally the finder hood is used for low level subjects, and also for much work when a tripod is employed. The Penta Prism or Exposure meter insert is ideal for eye level and moving subjects, and finally the lens magnifier (see page 11) for special category work.

Critical focusing

There are two approved auxiliary systems designed especially for normal close-up and macrophotography.

Split-Image Rangefinder No. 310. For use with the Penta Prism, Exposure meter insert and lens magnifier. Works according to the principle of a split-image rangefinder. Two partial images appear out of alignment until correctly focused. Particularly valuable for those with weak eyesight, or when working under unfavourable lighting conditions.

Lens reversal ring No. 159. In order to obtain critical definition when taking macro photographs with greater than $1\frac{1}{2}$ times magnification, the rear component of the camera lens should face the subject. This is achieved by means of the lens reversal ring, which is threaded for the lens mount, and extension tubes. When ordering please indicate clearly for which lens the ring is required.

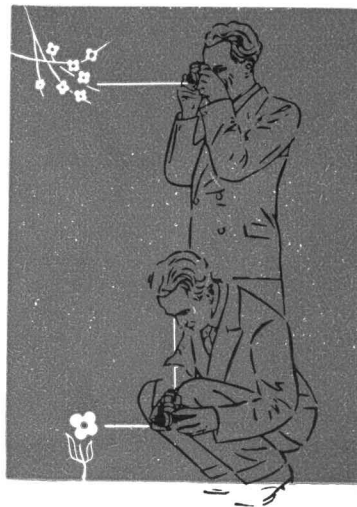

Oil and Vinegar

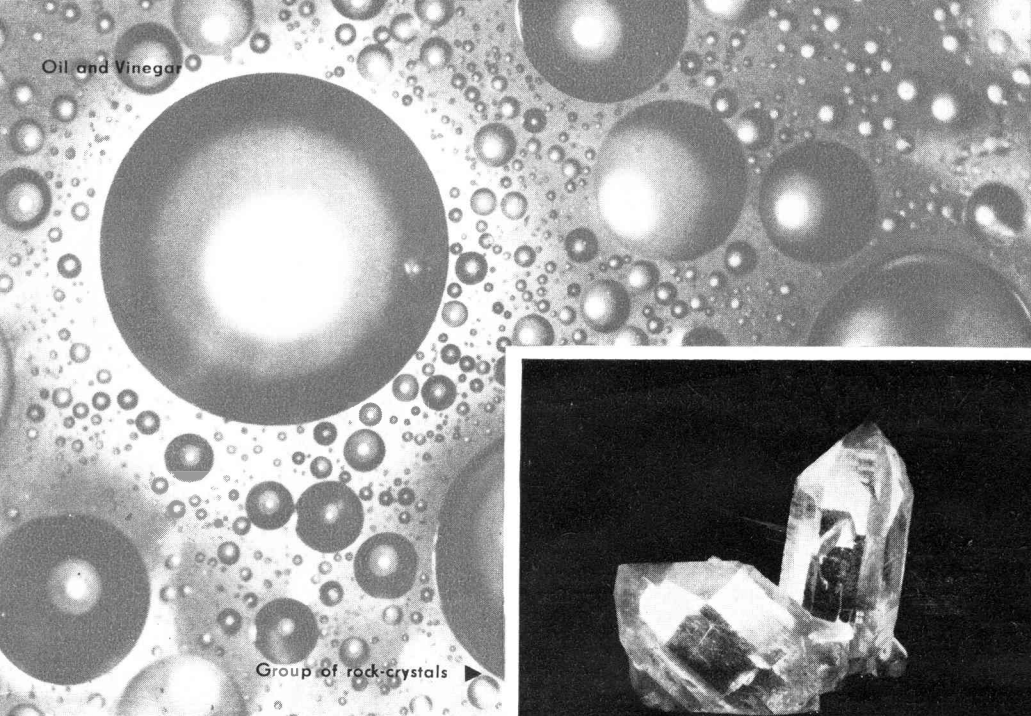

Group of rock-crystals

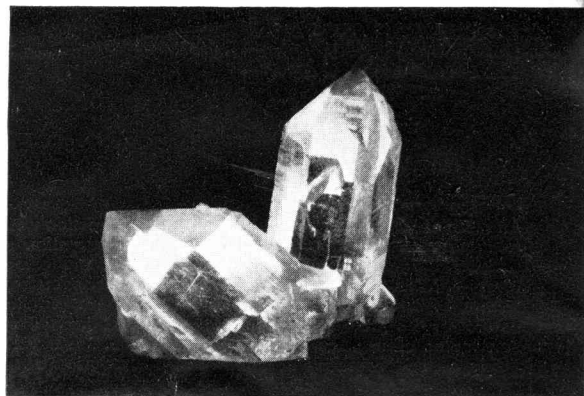

Working with the Ihagee VIELZWECK (Versal)

This most versatile instrument is invaluable for all forms of close-up and macrophotography. It is constructed on the unit principle, and all parts may be used separately, or combined, in varying manner. Thus you are in position to gradually complete the equipment in accordance with your individual requirements. Important parts of the Versal are:

Swing angle attachment No. 155.08. This has already been shown on pages 2 and 3. When in use you require bayonet adapter rings and extension tubes.

Bellows attachment No. 155.10 is recommended when objects are to be photographed frequently, and with ease. The bellows allows continuous extension from 3.5 to 22 cm scale of reproduction and image distance being quickly changed and without interruption. The equipment may also be used on a tripod allowing the camera to be rotated from horizontal to vertical position. Should you wish focusing extending to infinity you may use the special 50 mm f 2.8 lens in sunken mount (No. 128). There is a decided advantage in that when the camera has been firmly attached to a tripod the image distance is variable over a wide range by means of the ratched drive mechanism of the focusing slide allowing critical focusing to be achieved with ease and precision.

Transparency copying equipment No. 155.04. This is a valuable supplementary accessory used in conjunction with the bellows attachment. This enables you to copy your transparencies, make them from monochrome or colour negatives, to make duplicate monochrome negatives from colour reversal, or duplicates of colour reversal.

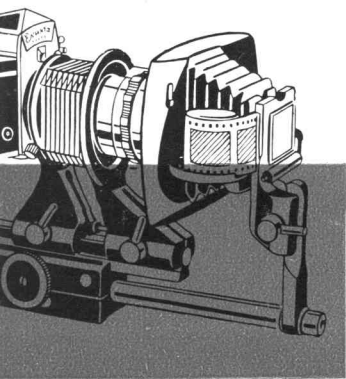

Bellows Attachment with
Transparency Copying Equipment

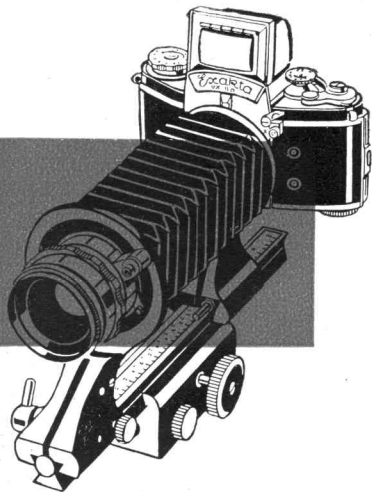

Bellows Attachment

EXAKTA

VxIIa



Repro attachments 1 (No.155.14) and 2 (No.155.15). With the aid of these you can easily reproduce paintings, drawings, periodical or magazine illustrations, documents, etc., etc., in the simplest possible manner. Also, for close-ups of stamps, coins, and similar objects, it is well suited. Generally, one would employ a vertical working position, but the equipment may also be used horizontally, with the help of a rigid table tripod. Equipment: Repro attachment 1 with bellows attachment, or Repro attachment 2 with swing angle attachment, both with two section metal column and wooden baseboard measuring 30×30 cm (for papers up to DIN A 4). For both accessories there is available a lighting equipment fitted with two reflectors (No.155.05).

Medical close-ups

of normal objects the EXAKTA achieves without difficulty when used in conjunction with the above mentioned accessories, and furthermore it may be used for photographing interior of human cavities. The special purpose equipment required which is at the disposal of professionally interested persons is as follows*):

KOLPOFOT No. 155.11. This Ihagee equipment employs electronic flash, thus guaranteeing pinpoint sharpness of all cavities accessible from outside the body (vagina, mouth cavities, larynx, etc.) in addition to photographs of the skin, the eyes, and numerous other external medical cases. Equipment of the KOLPOFOT comprises bellows attachment, special lens 135 mm f 4, with diaphragm scales to f 45 and central flash equipment ZB 3.

Endoscope Adapters No. 154. These connect the EXAKTA with surgical viewing instruments, enabling close-ups of the interior of cavities otherwise inaccessible, e.g. human bladder.

*) Special descriptions of "Kolpofot" and "Endoscopic photography with the EXAKTA" are available on request.

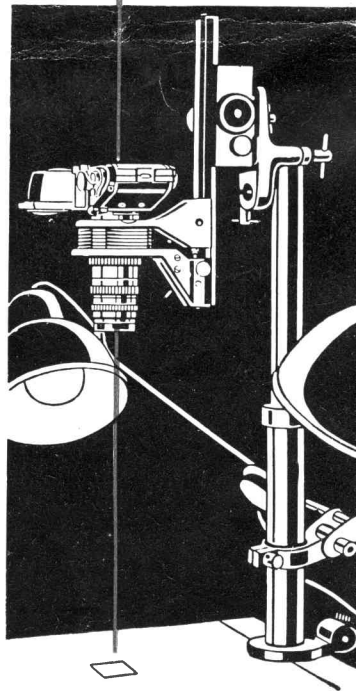

Repro Attachment with Lighting equipment

Proboscis of the common fly
Scale of reproduction in the negative 80:1
Additional magnification by printing
up to 400:1

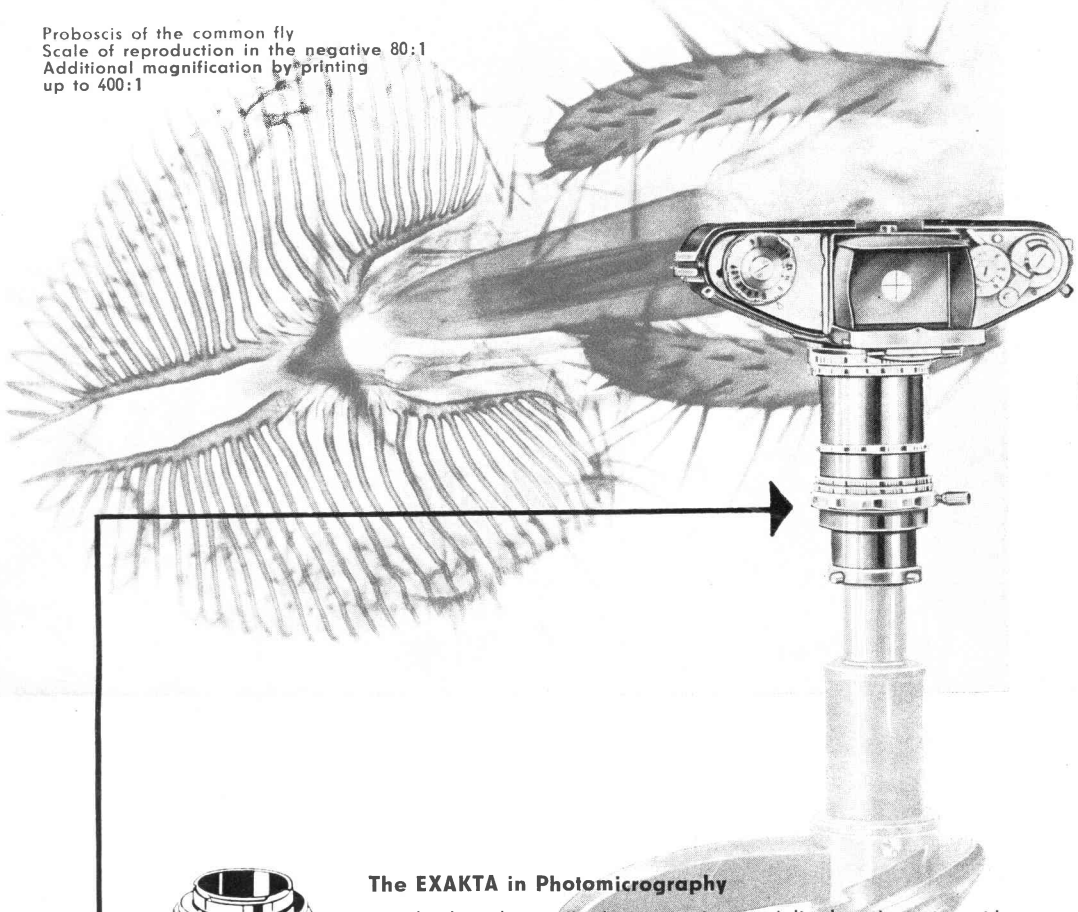

The EXAKTA in Photomicrography

completely replaces all other expensive specialised equipment, most important being the extreme economy of film and ease of working. Economical 35 mm film, monochrome or colour, is widely used for this work with the additional advantage of allowing serial shots and making possible short exposure times. By means of either of the two microscope attachments the camera is fitted to the microscope, and all the advantages that EXAKTA offers (true reflex focusing, freedom from parallax, etc.) can be utilised to the fullest possible extent. Photomicrographic work is usually undertaken without the camera lens, thus the actual microscope image is projected into the EXAKTA, making it possible for focusing on the ground glass screen. This facilitates the determination not only of the exact picture area, but also the decisive moment of exposure (essential for photographs of living, moving objects). It must be apparent that the sharpness of image is determined in the normal way on the focusing screen for which the "special glasses or screens" described on page 12 are available. Let us once more stress the basic facts: in photomicrography also the focusing screen image of EXAKTA is precisely in accordance with the final resulting negative or transparency.

Successful micro photographs require a microscope with optical equipment adapted to the new field of work. The normal objectives and oculars of compound microscopes generally have a curved field of view which in order to obtain uniform definition must be flattened by use of specially suited objectives and oculars. For more detailed information on this subject please consult current technical literature of our "Service Department". When writing kindly specify the kind of work in which you are interested, indicating all technical data concerning microscope and illumination equipment used.

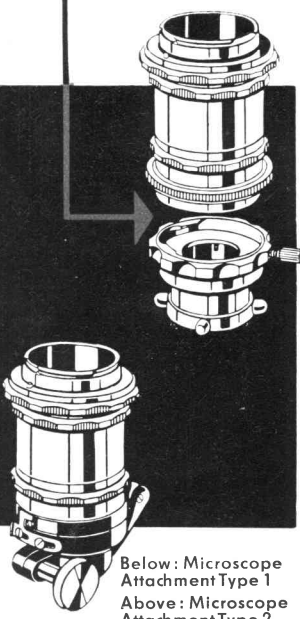

Below: Microscope Attachment Type 1
Above: Microscope Attachment Type 2

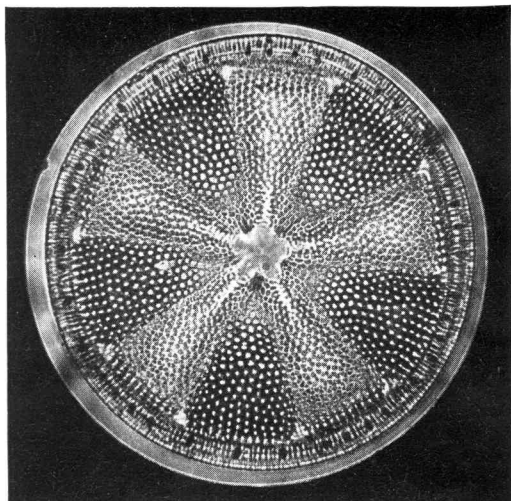

Capsule of a diatom
Scale of reproduction in the negative 90:1
Additional magnification by printing up to 270:1

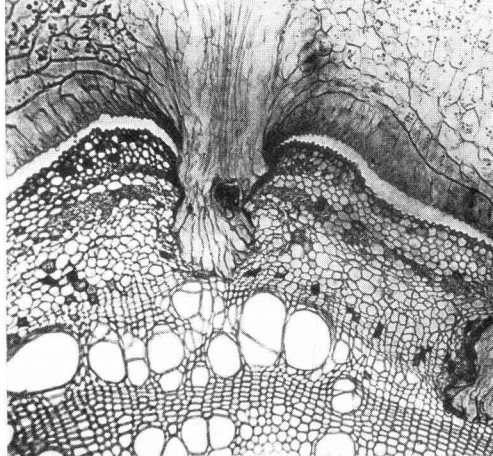

Suctorial organs of the Cuscuta (= parasite)
Scale of reproduction in the negative 30:1
Additional magnification by printing up to 90:1

EXAKTA

VX IIa

The two EXAKTA Microscope attachments

suitable for all earlier models, have been constructed so as to allow immediate suspension of photographic work when visual microscope inspection is desired. The microscope attachments have an inside diameter of 25 mm and may be attached to the ocular draw tube of most microscopes (first remove ocular, then slip on microscope attachment, tighten and replace ocular).

Microscope attachment Type 1 (No. 188) with hinged clamp. When photographic work is suspended the camera is not removed, but is moved to one side by means of the hinged top section.

Microscope attachment Type 2 (No. 153) with bayonet fitting. The top and bottom part of the microscope attachment may be separated so that the camera can be removed from the microscope in one swift and easy operation. The bottom part is fastened to the microscope by even pressure, whilst the top section has a quick removal device which necessitates only the unscrewing of the knurled locking screw. This is designed in such a manner as to fit the tube mounting of all modern microscopes with tubes of 25 mm diameter. This feature is essential when taking photomicrographs with slight magnification since in this case neither tube nor ocular of the microscope are used, but instead a suitable camera lens.

Both microscope attachments are so designed that when working with polarised light the analyser and the necessary compensators can be contained therein.

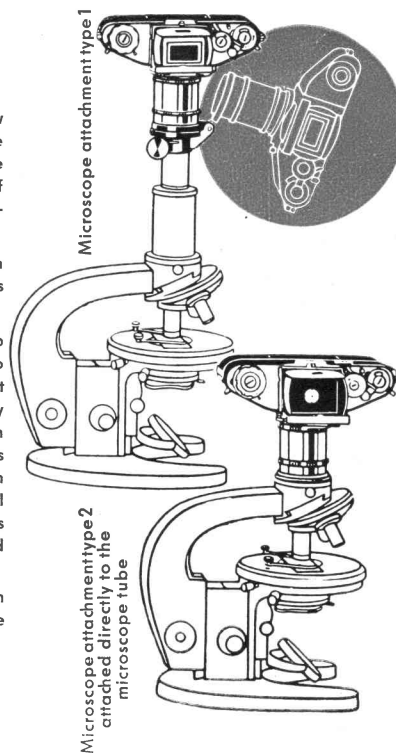

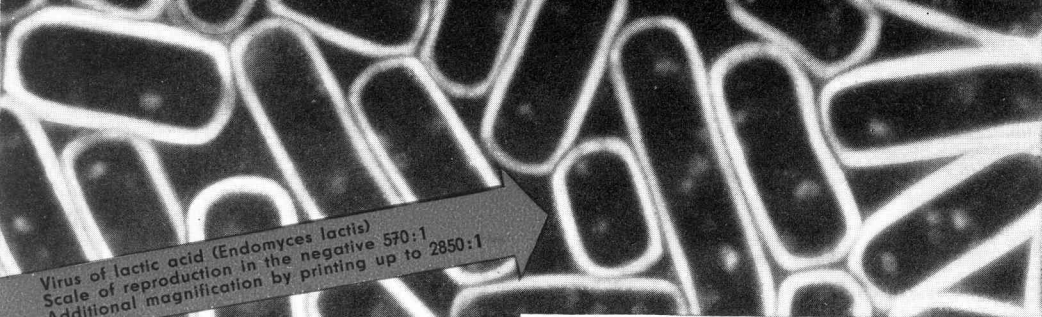

Virus of lactic acid (*Endomyces lactis*)
 Scale of reproduction in the negative 570:1
 Additional magnification by printing up to 2850:1

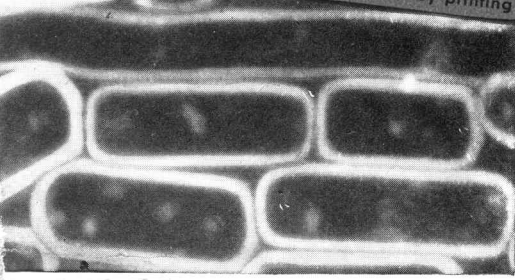

Complex of cancerous cells (after cancer of mamma)
 Scale of reproduction in the negative 270:1
 Additional magnification by printing up to 810:1

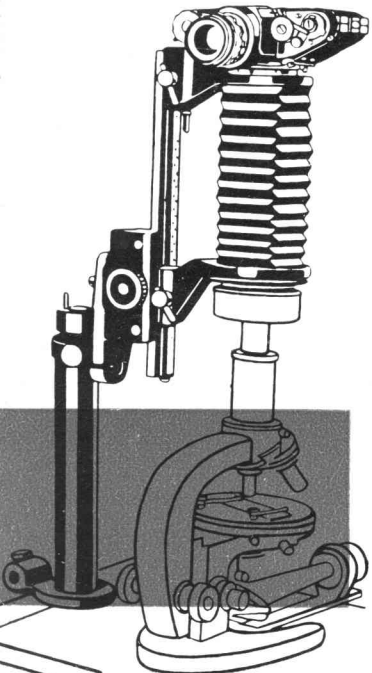
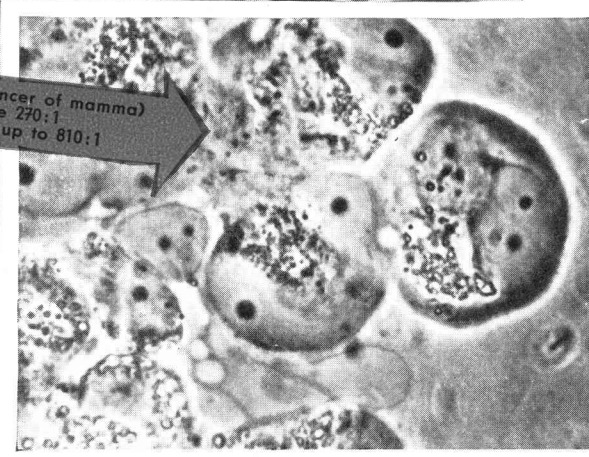

Repro attachment 1
 for Photomicrography

Photomicrography with Repro attachment 1 (No.155.14)

Occasionally photographic technicians wish not to have any mechanical connection between microscope and camera. This demand is fulfilled by repro attachment 1, whereby the EXAKTA is suspended above the microscope. Above all this working method is to be recommended when large magnification is involved. Two light baffle tubes are brought together without touching each other, in order to eliminate penetration of light. The scale of reproduction on the film may be adjusted by means of the bellows attachment. - For microphotographs with slight magnification the microscope ring 2 No.157 is available: it enables one to work without ocular and microscope tubes, but instead with a suitable camera lens.

Determining exact exposure time

in the whole field of photomicrography, stationary macrophotography, and for optical slides, can be achieved with the use of the Ihagee Macro-Micro Photometer No.167. It is fitted over the front plate of EXAKTA and a selenium top layer element is moved into the centre of the light source, thus allowing accurate measurement of the light source in the camera. For this purpose a micro-ammeter or galvanometer with light measurement scales are required (effective measuring field 5 ··· 30 μA, interior resistance 1000 ··· 5000 ohms). According to the initial measured calculations the exact exposure data determined first by trial exposures may be applied. In order to prevent unintentional exposure, the release button of the EXAKTA is automatically shielded during the light measuring operation. All increased exposure factors necessary when using bayonet adapter rings or tubes or other forms of extension are automatically calculated. (The Ihagee Macro-Micro Photometer effects an overall extension increase of 20 mm.)

Longitudinal section across haired skin
 Scale of reproduction in the negative 10:1
 Additional magnification by printing up to 25:1

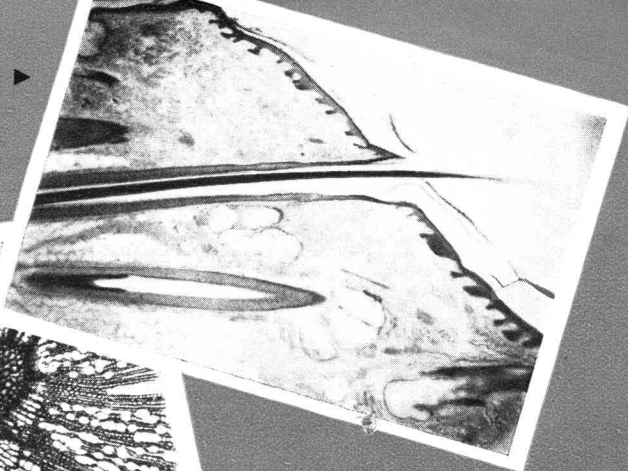

Alder twig (cross-cut)
 Scale of reproduction in the negative 56:1
 Additional magnification by printing up to 112:1

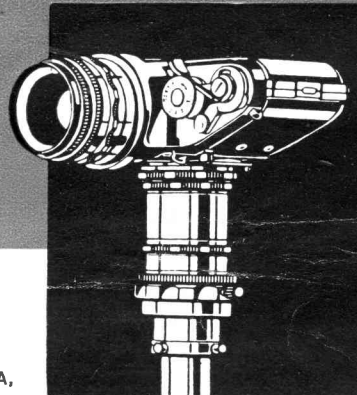
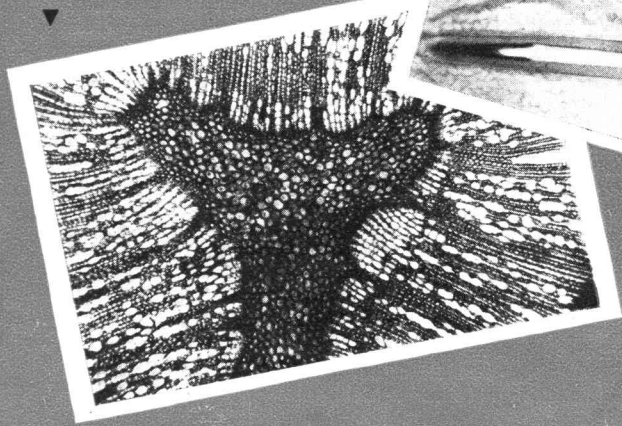

The lens magnifier at photomicrography

The best method for critical focusing

is by use of the Lens magnifier No.308, focusing system of the EXAKTA, particularly when undertaking Macro and Micro Photography. This focusing system is used in place of the finder hood, Penta Prism, or exposure meter insert. In order to view the reflex image with pinpoint definition, clear right to the corners and completely free of distortion, one uses the lens magnifier, and as magnifying glass one of the highly corrected standard or special lenses of the EXAKTA focused at infinity. The full reflex image may be seen with a lens of 50 mm focal length or greater, providing it is of a pattern which allows the eye near the front component, (e. g. not preset or automatic). The shorter the focal length, the greater magnification of the image, but with the wide angle lenses is shown only the centre of the picture field, the relative magnification of the focusing screen image amounts to: 8 times at focal length of 35 mm, 7 times at focal length of 40 mm, 5,4 times at focal length of 50 mm, 4,9 times at focal length of 58 mm, 3,8 times at focal length of 75 mm, 2,8 times at focal length of 100 mm, and 2,1 times at focal length of 135 mm.

Should there be no actual lens available for this purpose, or should you possess only the P. D. or A. P. D. lenses, which owing to design do not permit a sufficiently close proximity of the eye to the front component, then we recommend the top lens No.312 (see illustration page 2) designed especially for the lens magnifier. This top lens produces with the focusing screen system an overall five times magnification. One can survey the whole screen image comfortably and owing to the good optical performance of the lens, achieve critical focusing.

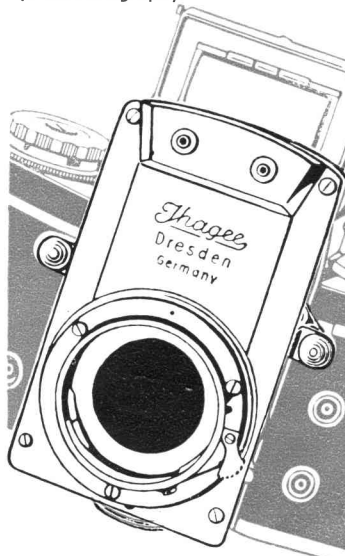

The Ihagee Macro-Micro Photometer

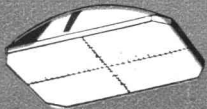
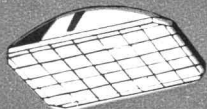
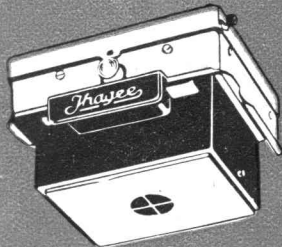

Special glasses for the focusing systems of the EXAKTA

Focusing aids for photomicrography and macrophotography

When using the EXAKTA and the many interchangeable focusing systems it is possible to adapt the focusing screen glasses to the many varying types of specialised work particularly photomicrography. For this latter type of work it is desirable to view the image on the ground glass focusing screen but focus by means of the brilliant microscope image. For this reason are there varying patterns of focusing screens, with clear centre spot and hairline cross. It is through the clear centre spot that the brilliant microscope image is visible, the hairline cross preventing the eye from subsequent accommodation (if microscope image and hairline cross are equally sharp, the subject is in perfect focus). Yet it is by no means necessary to use the special focusing screens permanently, for they can be interchanged for the standard ground glass or any other kind of screen available. We would recommend to change the reflex finder unit completely, but with Penta Prism, exposure meter insert, and lens magnifier the screen alone is changed. In addition to these, we supply a perfectly clear glass with hairline cross. In macrophotography all the special screens with clear glass or clear centre spot can be used extremely short lens to subject distances (about from a scale of reduction 1,5) but for normal photographs with the usual lens to subject distances (landscapes, architecture, etc., etc.) they are not suitable. In this context we refer you again to the distance meter (see page 5).

Type 4 available.

Finder Hood with Ground Glass and clear Centre Spot 3 mm = No. 301.03, 10 mm = No. 301.04, or with clear Glass No. 301.10 (all these types with hairline cross).

For Penta Prism, Exposure Meter Insert, and Lens Magnifier: Ground Glass with clear Centre Spot 3 mm = No. 302.03, 10 mm = No. 302.04 or with clear Glass No. 302.10 (all these types with hairline cross). N.B. we recommend for use with Penta Prism and Exposure meter insert the rotating rubber eye piece with mount for corrective lens, No. 315.

We can also deliver to specific order special pattern focusing screens for close-up and copy work, e.g. ground glass with cm. or mm. divisions, or with subsidiary lines intersecting at right angles, etc. For meticulously accurate screen observation and focusing in copy work the lens magnifier with top lens and fitted with plain ground glass is advantageous. (Plain ground glass No. 308.22.)

Should you desire additional information not contained in this prospectus please write to our „Service Department“.

There may be slight deviations between the camera models and the illustrations in this Booklet.

The EXAKTA-Photos in this Booklet are taken by

Page 1: E. Buschmann, Dresden; W. Seyfarth, Eisenach. Page 3: H. Helle, Tübingen; W. Neumann, Hameln; Dr. W. Schwermer, Freiburg. Page 4: K. Lischak, Stuttgart. Page 5: W. Neumann, Hameln. Page 6: R. Peter jr., Dresden; H. Zimmermann, Freiberg. Page 7: Ihagee-Archiv. Page 8: W. Seyfarth, Eisenach. Page 9: U. Leonhardt, Dresden. (2). Page 10: Dr. Kölling (2) and Dr. Siering, Jena. Page 11: W. Seyfarth, Eisenach; Dr. H. Höring, Rochlitz.

Exclusive Sales and Service Representative in U.S.A.
for Ihagee Camera Works
EXAKTA Camera Company
705 Bronx River Road, Bronxville 8, N.Y.

IHAGEE CAMERA WORKS AG DRESDEN A 16
(GERMANY)

